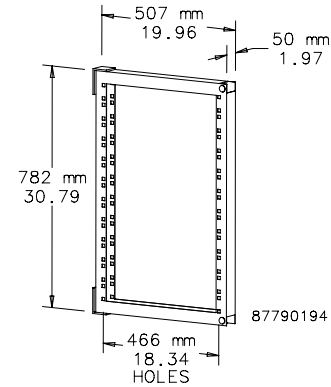

PARTIAL SWING-OUT RACK FRAME **A-T-O**

This 19-in. Rack Frame is used when a smaller, medium-duty swing-out frame is desired. Light-weight rack equipment fits nicely into this 800-mm tall swing-out frame providing 90 degrees of rotation and increased accessibility.

- Side hinge brackets are used to mount the swing frame, allowing free access above and below the swing frame
- Used with any height enclosure and hinged on the right or left
- Maximum equipment load is 100 lb.
- Furnished with hinges, two quarter-turn latches and mounting hardware
- RAL 7035 textured gray finish
- Complies with ANSI/EIA RS-310-D rack mounting standards

1. *Swing-Out Rack Frame assemblies are supplied with mounting supports. Swing-Out Rack Frames can also be installed in right, left or both bays of 1200-mm wide frames using center uprights.*
2. *Swing-out mounting supports mount to inside of frame at any vertical location.*
3. *Mounting supports and swing-out frame can be located deeper into frame using grid system straps. Deeper mounting affects the degree of opening of swing-out frame.*

BULLETIN: P20

| Catalog Number | Fits Frame Width | Rack Units |
|----------------|------------------|------------|
| PSF6 | 600 | 16 |
| PSF8 | 800 | 16 |

HEAVY-DUTY SWING-OUT RACK FRAME **A-T-O**

- Allows 19-in. rack equipment to pivot out of the enclosure frame for better accessibility. The frames mount on hinges capable of 120-degree rotation. Hinges that provide 170-degree rotation are optional.
- Spring-loaded pivot post makes installation easy
- Rack Frames are available for 600-, 700- and 800-mm wide enclosure frames
- Mounting supports for an 800-mm wide enclosure frame permit you to either center the rack-mounting frame or position it right or left. The frame can also pivot from either the left or the right for maximum flexibility.
- Mounting supports can be assembled to the top and bottom of the frame for full-height rack-mounting frames. Smaller rack-mounting frames can be mounted to the vertical frame members or to the grid straps. Order separately.
- Furnished with hinges, two quarter-turn latches and mounting hardware RAL 7035 textured gray finish
- Complies with ANSI/EIA RS-310-D rack-mounting standards
- Maximum equipment load is 300 lb.
- Mounting holes accommodate either English or metric cage nuts, which are ordered separately
 1. *Swing-Out Rack Frame assemblies are supplied with mounting supports. Swing-Out Rack Frames can also be installed in right, left or both bays of 1200-mm wide frames using center uprights.*
 2. *Swing-out mounting supports mount to inside of frame at any vertical location.*
 3. *Mounting supports and swing-out frame can be located deeper into frame using grid system straps. Deeper mounting affects the degree of opening of swing-out frame.*

| Catalog Number | H mm/in. | W mm/in. | Rack Units | Fits Frame Height | Fits Frame Width |
|----------------|---------------|--------------|------------|-------------------|------------------|
| PSF76 | 538 21.18 | 496 19.53 | 10 | 700 or taller | 600 |
| PSF77 | 538 21.18 | 496 19.53 | 10 | 700 or taller | 700 |
| PSF78 | 538 21.18 | 496 19.53 | 10 | 700 or taller | 800 |
| PSF146 | 1215 47.83 | 496 19.53 | 25 | 1400 or taller | 600 |
| PSF148 | 1215 47.83 | 496 19.53 | 25 | 1400 or taller | 800 |
| PSF168 | 1438 63.58 | 496 19.53 | 30 | 1600 or taller | 800 |
| PSF186 | 1615 63.58 | 496 19.53 | 34 | 1800 or taller | 600 |
| PSF188 | 1615 63.58 | 496 19.53 | 34 | 1800 or taller | 800 |
| PSF206 | 1838 72.36 | 496 19.53 | 39 | 2000 or taller | 600 |
| PSF207 | 1838 72.36 | 496 19.53 | 39 | 2000 or taller | 700 |
| PSF208 | 1838 72.36 | 496 19.53 | 39 | 2000 or taller | 800 |
| PSF226 | 2015 79.33 | 496 19.53 | 43 | 2200 tall | 600 |
| PSF227 | 2015 79.33 | 496 19.53 | 43 | 2200 tall | 700 |
| PSF228 | 2015 79.33 | 496 19.53 | 43 | 2200 tall | 800 |

BULLETIN: P20

Standard 120° Frame Hinging

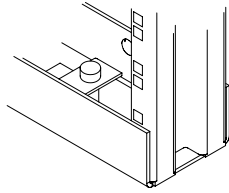

120° Mounting Position

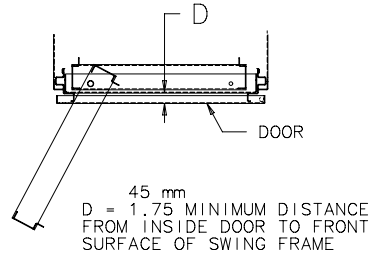

Maximum Installation Depth for 600 mm Wide Enclosures

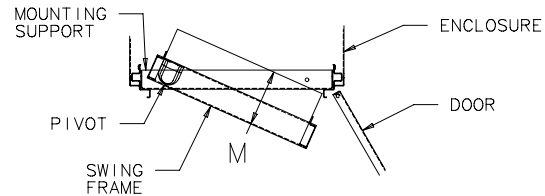
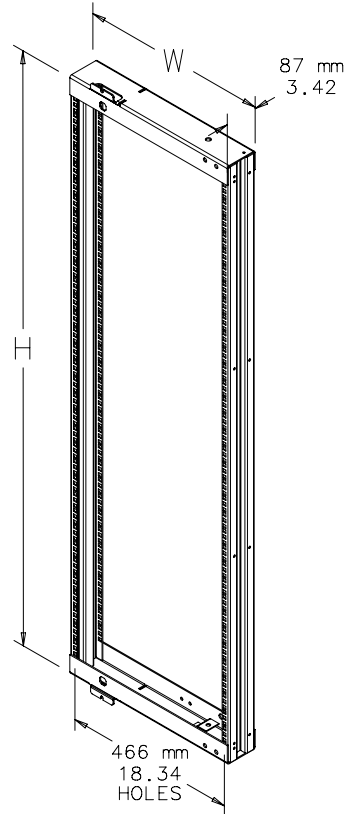

M = Max Installation Depth = 216 mm (8.50 in.)

Maximum Installation Depth for 700 mm Wide Enclosures

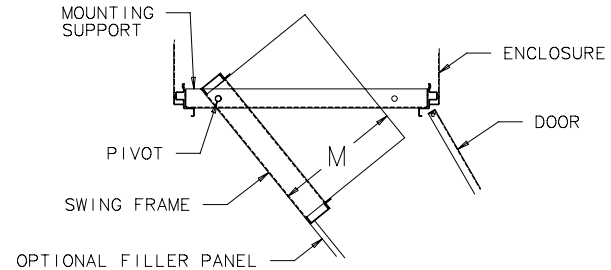

M = Max Installation Depth = 394 mm (15.50 in.)

Maximum Installation Depth for 800 mm Wide Enclosures

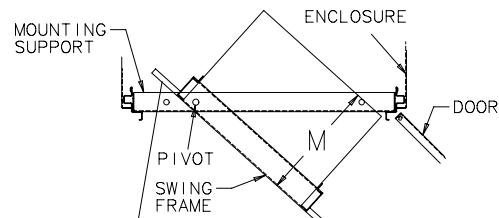

Center Position

M = Max Installation Depth = 394 mm (15.50 in.)

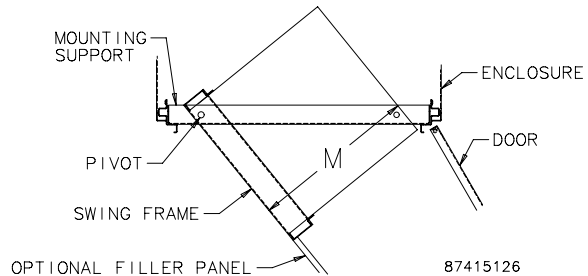

Side Position

M = Max Installation Depth = 514 mm (20.25 in.)

87415126

170-DEGREE HINGE KIT **ATO**

Use this kit in conjunction with the Heavy-Duty Swing-Out Frame. It provides increased accessibility to the back of rack equipment.

BULLETIN: P20

| Catalog Number | Fits Cabinets |
|----------------|------------------|
| PSF170K | 600, 700 and 800 |

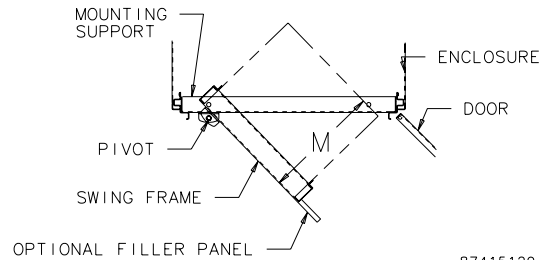
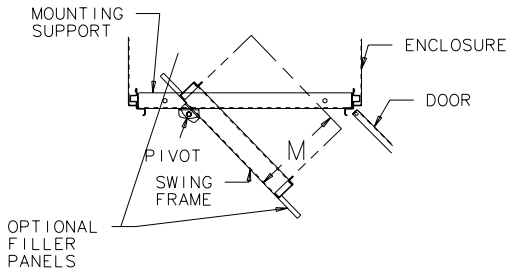
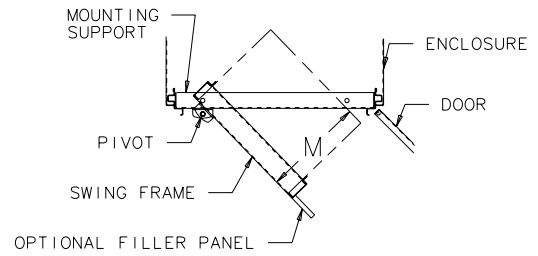
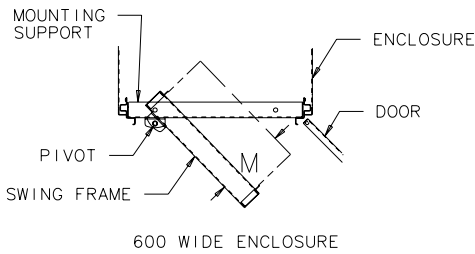
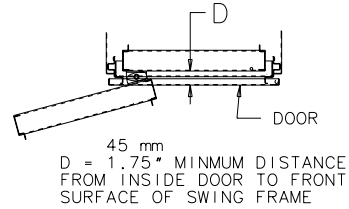
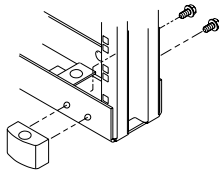
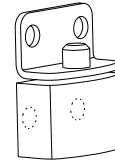

87415129

SWING-OUT GUIDES **A-T-O**

Guides can be mounted to a Heavy-Duty Swing-Out Rack Frame to provide extra support for rack equipment. Plated steel guides are furnished in pairs with mounting hardware included.

BULLETIN: P20

| Catalog Number | Description |
|----------------|------------------|
| PSFG | Swing-Out Guides |

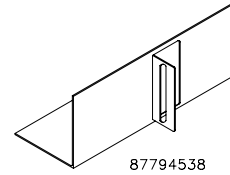

STOP ARM KIT **A-T-O**

Used with Heavy-Duty Swing-Out Rack Frames to lock the frame in the open position. Consists of stop arm and mounting hardware.

BULLETIN: P20

| Catalog Number | Description |
|----------------|-------------------------|
| PSAK120 | 120-degree Stop Arm Kit |

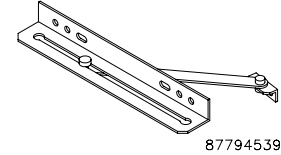

FILLER PANEL KIT **A-T-O**

Used when mounting Heavy-Duty Swing-Out Rack Frames in 700- or 800-mm wide frames. The Filler Panel occupies the extra space between the frame and the swing frame. Includes a handle and all the hardware for mounting to the Swing-Out Rack Frame.

BULLETIN: P20

| Catalog Number | Swing Frame Height | Enclosure Width | Mounting |
|----------------|--------------------|-----------------|---------------|
| PFPK77LR | 700 | 700 | Left or Right |
| PFPK78C | 700 | 800 | Center |
| PFPK147LR | 1400 | 700 | Left or Right |
| PFPK148C | 1400 | 800 | Center |
| PFPK167LR | 1600 | 700 | Left or Right |
| PFPK168LR | 1600 | 800 | Left or Right |
| PFPK168C | 1600 | 800 | Center |
| PFPK187LR | 1800 | 700 | Left or Right |
| PFPK188LR | 1800 | 800 | Left or Right |
| PFPK188C | 1800 | 800 | Center |
| PFPK208LR | 2000 | 800 | Left or Right |
| PFPK208C | 2000 | 800 | Center |
| PFPK227LR | 2200 | 700 | Left or Right |
| PFPK228LR | 2200 | 800 | Left or Right |
| PFPK228C | 2200 | 800 | Center |

