

LAY-IN GALVANIZED WIREWAY, NEMA TYPE 1



45° Elbow (bottom) and Telescope Fitting (top)

INDUSTRY STANDARDS

UL 870 Listed; File No. E27524
 cUL Listed per CSA C22.2 No. 26; File No. E27524

NEMA/EEMAC: Type 1
 IEC 60529, IP30

APPLICATION

This galvanized wireway features an open design on one side so wires and cables can be laid in safely along the entire run without pulling. A variety of lengths and fittings accommodate design requirements.

FEATURES

- Flat cover design
- Open top assembly
- Available with or without knockouts
- Keyhole screw slots on flat covers
- Knockouts on wireway sides

SPECIFICATIONS

- 16 or 14 gauge galvanized steel covers and bodies

FINISH

Unpainted galvanized steel

This drawing illustrates how most of the Hoffman NEMA Type 1 lay-in wireway sections and fittings could be used in an actual wireway run. The covers have been omitted to present the lay-in feature more clearly. Many different sections and fittings can be combined in any configuration desired.

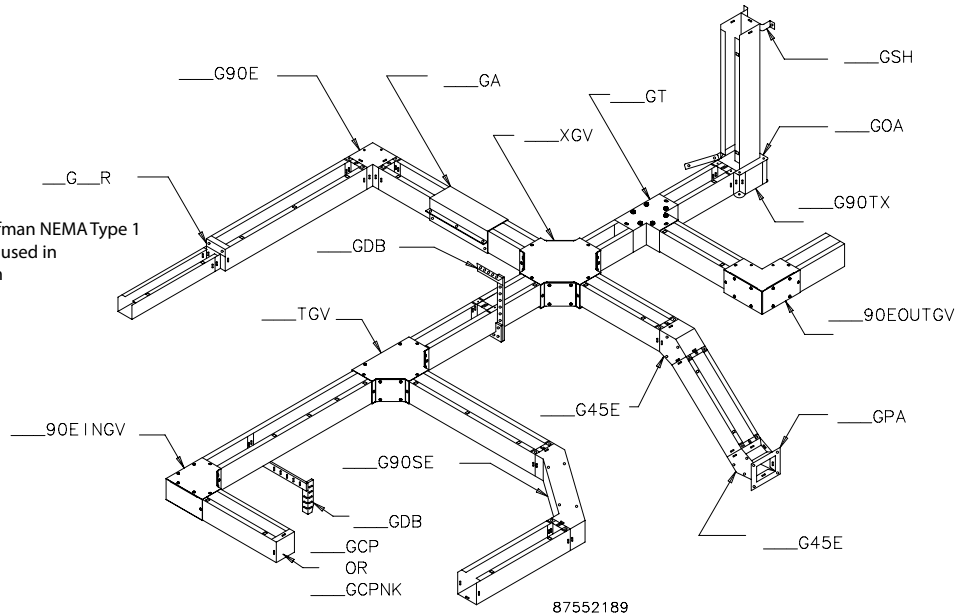

87552189

Standard Product Selection Matrix

Description	2.50 x 2.50 in. (64 x 64 mm)	4.00 x 4.00 in. (102 x 102 mm)	6.00 x 6.00 in. (152 x 152 mm)	8.00 x 8.00 in. (203 x 203 mm)	10.00 x 10.00 in. (254 x 254 mm)	12.00 x 12.00 in. (305 x 305 mm)
12.00-in. (305-mm) Straight Section with knockouts	—	F44T112GVWK	F66T112GVWK	F88T112GVWK	—	—
12.00-in. (305-mm) Straight Section without knockouts	F22T112GV	F44T112GV	F66T112GV	F88T112GV	F1010T112GV	F1212T112GV
18.00-in. (455-mm) Straight Section without knockouts	—	F44T118GV	F66T118GV	F88T118GV	—	—
24.00-in. (610-mm) Straight Section with knockouts	F22T124GVWK	F44T124GVWK	F66T124GVWK	F88T124GVWK	—	—
24.00-in. (610-mm) Straight Section without knockouts	F22T124GV	F44T124GV	F66T124GV	F88T124GV	F1010T124GV	F1212T124GV
24.00-in. (610-mm) Straight Section without knockouts	F22T136GVWK	F44T136GVWK	F66T136GVWK	F88T136GVWK	—	—
36.00-in. (914-mm) Straight Section without knockouts	F22T136GV	F44T136GV	F66T136GV	F88T136GV	F1010T136GV	F1212T136GV
48.00-in. (1219-mm) Straight Section with knockouts	—	F44T148GVWK	F66T148GVWK	F88T148GVWK	—	—
48.00-in. (1219-mm) Straight Section without knockouts	F22T148GV	F44T148GV	F66T148GV	F88T148GV	F1010T148GV	F1212T148GV
60.00-in. (1524-mm) Straight Section with knockouts	F22T160GVWK	F44T160GVWK	F66T160GVWK	F88T160GVWK	—	—
60.00-in. (1524-mm) Straight Section without knockouts	F22T160GV	F44T160GV	F66T160GV	F88T160GV	F1010T160GV	F1212T160GV
72.00-in. (1829-mm) Straight Section with knockouts	—	F44T172GVWK	F66T172GVWK	F88T172GVWK	—	—
72.00-in. (1829-mm) Straight Section without knockouts	—	F44T172GV	F66T172GV	F88T172GV	F1010T172GV	—
120.00-in. (3048-mm) Straight Section with knockouts	F22T1120GVWK	F44T1120GVWK	F66T1120GVWK	F88T1120GVWK	—	—
120.00-in. (3048-mm) Straight Section without knockouts	F22T1120GV	F44T1120GV	F66T1120GV	F88T1120GV	F1010T1120GV	F1212T1120GV
90° Flush Tee	F22GTGV	F44GTGV	F66GTGV	F88GTGV	F1010GTGV	F1212GTGV
Sweep Tee	F22TGV	F44TGV	F66TGV	F88TGV	F1010TGV	F1212TGV
Cross Fitting	F22XGV	F44XGV	F66XGV	F88XGV	F1010XGV	F1212XGV
90° Sweep Elbow	F2290SEGV	F4490SEGV	F6690SEGV	F8890SEGV	F101090SEGV	F121290SEGV
90° Elbow-Tee-Cross	F2290TXGV	F4490TXGV	F6690TXGV	F8890TXGV	F101090TXGV	F121290TXGV
90° Elbow	F2290EGV	F4490EGV	F6690EGV	F8890EGV	F101090EGV	F121290EGV
90° Elbow Outside Opening	F2290EINGV	F4490EINGV	F6690EINGV	F8890EINGV	F101090EINGV	F121290EINGV
90° Elbow Outside Opening	F2290EOUTGV	F4490EOUTGV	F6690EOUTGV	F8890EOUTGV	F101090EOUTGV	F121290EOUTGV
45° Elbow	F2245EGV	F4445EGV	F6645EGV	F8845EGV	F101045EGV	F121245EGV
Telescope Fitting ^a	F22GAGV	F44GAGV	F66GAGV	F88GAGV	F1010GAGV	F1212GAGV
Panel Adapter	F22GPAGV	F44GPAGV	F66GPAGV	F88GPAGV	F1010GPAGV	F1212GPAGV
Closure Plate with knockouts	F22GCPGV	F44GCPGV	F66GCPGV	F88GCPGV	—	F1212GCPGV
Closure Plate without knockouts	F22GCPNKGV	F44GCPNKGV	F66GCPNKGV	F88GCPNKGV	F1010GCPNKGV	F1212GCPNKGV
Reducer	—	F44G22R	F66G44R	F88G66R	F1010G88R	F1212G88R 1212G1010R
Drop and Bracket Hanger	F22GDB	F44GDB	F66GDB	F88GDB	F1010GDB	F1212GDB
Support Hanger	F22GSHGV	F44GSHGV	F66GSHGV	F88GSHGV	F1010GSHGV	F1212GSHGV
Universal U-Connector	F22GUCGV	F44GUCGV	F66GUCGV	F88GUCGV	F1010GUCGV	F1212GUCGV

^aNot UL/cUL listed.

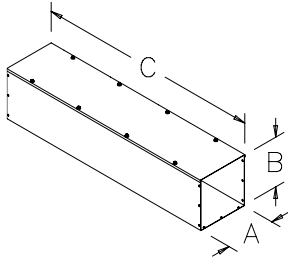
STRAIGHT SECTION

87794679

Available in lengths from 12.00 in. (305 mm) to 120.00 in. (3048 mm), with or without knockouts.

BULLETIN: F40, F40G

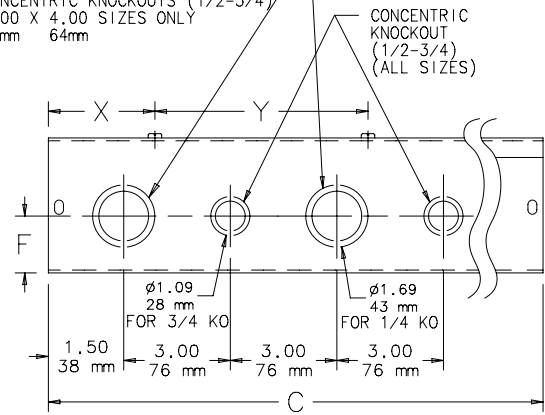
 CONCENTRIC KNOCKOUTS (1-1 1/4)
 4.00 X 4.00 AND 6.00 X 6.00
 102mm 102mm 152mm 152mm
 CONCENTRIC KNOCKOUTS (1/2-3/4)
 4.00 X 4.00 SIZES ONLY
 64mm 64mm

87794743

 PATTERN REPEATS EVERY 12.00
 305 mm

Straight Sections

Catalog Number	AxBxC in.	AxBxC mm	Number of Knockouts, .50 in.-.75 in.	Number of Knockouts, 1.00 in.-1.25 in.	F (in.)	F (mm)	X (in.)	X (mm)	Y (in.)	Y (mm)
F22T112GV	2.50 x 2.50 x 12.00	64 x 64 x 305	—	—	—	—	—	—	—	—
F22T1124GVVK	2.50 x 2.50 x 24.00	64 x 64 x 610	16	—	1.06	27	6.00	152	12.00	305
F22T1124GV	2.50 x 2.50 x 24.00	64 x 64 x 610	—	—	—	—	—	—	—	—
F22T1136GVVK	2.50 x 2.50 x 36.00	64 x 64 x 914	24	—	1.06	27	6.00	152	12.00	305
F22T1136GV	2.50 x 2.50 x 36.00	64 x 64 x 914	—	—	—	—	—	—	—	—
F22T1148GV	2.50 x 2.50 x 48.00	64 x 64 x 1219	—	—	—	—	—	—	—	—
F22T1160GVVK	2.50 x 2.50 x 60.00	64 x 64 x 1524	40	—	1.06	27	6.00	152	12.00	305
F22T1160GV	2.50 x 2.50 x 60.00	64 x 64 x 1524	—	—	—	—	—	—	—	—
F22T1120GVVK	2.50 x 2.50 x 120.00	64 x 64 x 3048	80	—	1.06	27	6.00	152	12.00	305
F22T1120GV	2.50 x 2.50 x 120.00	64 x 64 x 3048	—	—	—	—	—	—	—	—
F44T112GVVK	4.00 x 4.00 x 12.00	102 x 102 x 305	4	4	1.62	41	3.00	76	6.00	152
F44T112GV	4.00 x 4.00 x 12.00	102 x 102 x 305	—	—	—	—	—	—	—	—
F44T118GV	4.00 x 4.00 x 18.00	102 x 102 x 455	—	—	—	—	—	—	—	—
F44T118GVVK	4.00 x 4.00 x 18.00	102 x 102 x 455	—	—	—	—	—	—	—	—
F44T124GVVK	4.00 x 4.00 x 24.00	102 x 102 x 610	8	8	1.62	41	6.00	152	12.00	305
F44T124GV	4.00 x 4.00 x 24.00	102 x 102 x 610	—	—	—	—	—	—	—	—
F44T136GVVK	4.00 x 4.00 x 36.00	102 x 102 x 914	12	12	1.62	41	6.00	152	12.00	305
F44T136GV	4.00 x 4.00 x 36.00	102 x 102 x 914	—	—	—	—	—	—	—	—
F44T148GVVK	4.00 x 4.00 x 48.00	102 x 102 x 1219	16	16	1.62	41	6.00	152	12.00	305
F44T148GV	4.00 x 4.00 x 48.00	102 x 102 x 1219	—	—	—	—	—	—	—	—
F44T160GVVK	4.00 x 4.00 x 60.00	102 x 102 x 1524	20	20	1.62	41	6.00	152	12.00	305
F44T160GV	4.00 x 4.00 x 60.00	102 x 102 x 1524	—	—	—	—	—	—	—	—
F44T172GVVK	4.00 x 4.00 x 72.00	102 x 102 x 1829	24	24	1.62	41	6.00	152	12.00	305
F44T172GV	4.00 x 4.00 x 72.00	102 x 102 x 1829	—	—	—	—	—	—	—	—
F44T120GVVK	4.00 x 4.00 x 120.00	102 x 102 x 3048	40	40	1.62	41	6.00	152	12.00	305
F44T120GV	4.00 x 4.00 x 120.00	102 x 102 x 3048	—	—	—	—	—	—	—	—
F66T112GVVK	6.00 x 6.00 x 12.00	152 x 152 x 305	4	4	1.62	41	6.00	152	12.00	305
F66T112GV	6.00 x 6.00 x 12.00	152 x 152 x 305	—	—	—	—	—	—	—	—
F66T118GV	6.00 x 6.00 x 18.00	152 x 152 x 455	—	—	—	—	—	—	—	—
F66T118GVVK	6.00 x 6.00 x 18.00	152 x 152 x 455	—	—	—	—	—	—	—	—
F66T124GVVK	6.00 x 6.00 x 24.00	152 x 152 x 610	8	8	1.62	41	6.00	152	12.00	305
F66T124GV	6.00 x 6.00 x 24.00	152 x 152 x 610	—	—	—	—	—	—	—	—
F66T136GVVK	6.00 x 6.00 x 36.00	152 x 152 x 914	12	12	1.62	41	6.00	152	12.00	305
F66T136GV	6.00 x 6.00 x 36.00	152 x 152 x 914	—	—	—	—	—	—	—	—
F66T148GVVK	6.00 x 6.00 x 48.00	152 x 152 x 1219	16	16	1.62	41	6.00	152	12.00	305
F66T148GV	6.00 x 6.00 x 48.00	152 x 152 x 1219	—	—	—	—	—	—	—	—
F66T160GVVK	6.00 x 6.00 x 60.00	152 x 152 x 1524	20	20	1.62	41	6.00	152	12.00	305
F66T160GV	6.00 x 6.00 x 60.00	152 x 152 x 1524	—	—	—	—	—	—	—	—
F66T172GVVK	6.00 x 6.00 x 72.00	152 x 152 x 1829	24	24	1.62	41	6.00	152	12.00	305
F66T172GV	6.00 x 6.00 x 72.00	152 x 152 x 1829	—	—	—	—	—	—	—	—
F66T120GVVK	6.00 x 6.00 x 120.00	152 x 152 x 3048	40	40	1.62	41	6.00	152	12.00	305
F66T120GV	6.00 x 6.00 x 120.00	152 x 152 x 3048	—	—	—	—	—	—	—	—
F88T112GVVK	8.00 x 8.00 x 12.00	203 x 203 x 305	4	4	1.62	41	3.00	76	6.00	152
F88T112GV	8.00 x 8.00 x 12.00	203 x 203 x 305	—	—	—	—	—	—	—	—
F88T118GV	8.00 x 8.00 x 18.00	203 x 203 x 455	—	—	—	—	—	—	—	—
F88T118GVVK	8.00 x 8.00 x 18.00	203 x 203 x 455	—	—	—	—	—	—	—	—
F88T124GVVK	8.00 x 8.00 x 24.00	203 x 203 x 610	8	8	1.62	41	6.00	152	12.00	305
F88T124GV	8.00 x 8.00 x 24.00	203 x 203 x 610	—	—	—	—	—	—	—	—
F88T136GVVK	8.00 x 8.00 x 36.00	203 x 203 x 914	12	12	1.62	41	6.00	152	12.00	305
F88T136GV	8.00 x 8.00 x 36.00	203 x 203 x 914	—	—	—	—	—	—	—	—

Catalog Number	AxBxC in.	AxBxC mm	Number of Knockouts, .50 in.-.75 in.	Number of Knockouts, 1.00 in.-1.25 in.	F (in.)	F (mm)	X (in.)	X (mm)	Y (in.)	Y (mm)
F88T148GVWK	8.00 x 8.00 x 48.00	203 x 203 x 1219	16	16	1.62	41	6.00	152	12.00	305
F88T148GV	8.00 x 8.00 x 48.00	203 x 203 x 1219	—	—	—	—	—	—	—	—
F88T160GVWK	8.00 x 8.00 x 60.00	203 x 203 x 1524	20	20	1.62	41	6.00	152	12.00	305
F88T160GV	8.00 x 8.00 x 60.00	203 x 203 x 1524	—	—	—	—	—	—	—	—
F88T172GVWK	8.00 x 8.00 x 72.00	203 x 203 x 1829	24	24	1.62	41	6.00	152	12.00	305
F88T172GV	8.00 x 8.00 x 72.00	203 x 203 x 1829	—	—	—	—	—	—	—	—
F88T1120GVWK	8.00 x 8.00 x 120.00	203 x 203 x 3048	40	40	1.62	41	6.00	152	12.00	305
F88T1120GV	8.00 x 8.00 x 120.00	203 x 203 x 3048	—	—	—	—	—	—	—	—
F1010T112GV	10.00 x 10.00 x 12.00	254 x 254 x 305	—	—	—	—	—	—	—	—
F1010T124GV	10.00 x 10.00 x 24.00	254 x 254 x 610	—	—	—	—	—	—	—	—
F1010T136GV	10.00 x 10.00 x 36.00	254 x 254 x 914	—	—	—	—	—	—	—	—
F1010T148GV	10.00 x 10.00 x 48.00	254 x 254 x 1219	—	—	—	—	—	—	—	—
F1010T160GV	10.00 x 10.00 x 60.00	254 x 254 x 1524	—	—	—	—	—	—	—	—
F1010T172GV	10.00 x 10.00 x 72.00	254 x 254 x 1829	—	—	—	—	—	—	—	—
F1010T1120GV	10.00 x 10.00 x 120.00	254 x 254 x 3048	—	—	—	—	—	—	—	—
F1212T112GV	12.00 x 12.00 x 12.00	305 x 305 x 305	—	—	—	—	—	—	—	—
F1212T124GV	12.00 x 12.00 x 24.00	305 x 305 x 610	—	—	—	—	—	—	—	—
F1212T136GV	12.00 x 12.00 x 36.00	305 x 305 x 914	—	—	—	—	—	—	—	—
F1212T148GV	12.00 x 12.00 x 48.00	305 x 305 x 1219	—	—	—	—	—	—	—	—
F1212T160GV	12.00 x 12.00 x 60.00	305 x 305 x 1524	—	—	—	—	—	—	—	—
F1212T1120GV	12.00 x 12.00 x 120.00	305 x 305 x 3048	—	—	—	—	—	—	—	—

GALVANIZED 90-DEGREE FLUSH TEE

For flush mounting against a vertical or horizontal surface.

BULLETIN: F40GF

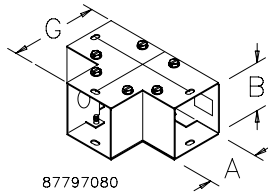

Catalog Number	AxB in./mm	G in./mm
F22GTGV	2.50 x 2.50 64 x 64	4.50 114
F44GTGV	4.00 x 4.00 102 x 102	6.00 152
F66GTGV	6.00 x 6.00 152 x 152	8.00 203
F88GTGV	8.00 x 8.00 203 x 203	10.00 254
F1010GTGV	10.00 x 10.00 254 x 254	12.00 305
F1212GTGV	12.00 x 12.00 305 x 305	14.00 356

GALVANIZED SWEEP TEE

For large radius turns. Mounts against vertical or horizontal surfaces. Top and inside covers removable.

BULLETIN: F40GF

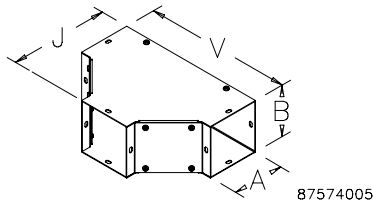

Catalog Number	AxB in./mm	J in./mm	V in./mm
F22TGV	2.50 x 2.50 64 x 64	6.50 165	10.35 263
F44TGV	4.00 x 4.00 102 x 102	8.00 203	11.85 301
F66TGV	6.00 x 6.00 152 x 152	10.00 254	13.85 352
F88TGV	8.00 x 8.00 203 x 203	12.00 305	15.84 402
F1010TGV	10.00 x 10.00 254 x 254	14.00 356	17.84 453
F1212TGV	12.00 x 12.00 305 x 305	16.00 406	19.84 504

GALVANIZED CROSS FITTING

For routing cables in four directions. Top, bottom and side covers removable.

BULLETIN: F40GF

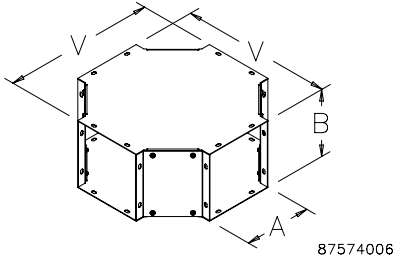

Catalog Number	AxB in./mm	V in./mm
F22XGV	2.50 x 2.50 64 x 64	10.35 263
F44XGV	4.00 x 4.00 102 x 102	11.85 301
F66XGV	6.00 x 6.00 152 x 152	13.85 352
F88XGV	8.00 x 8.00 203 x 203	15.84 402
F1010XGV	10.00 x 10.00 254 x 254	17.84 453
F1212XGV	12.00 x 12.00 305 x 305	19.84 504

GALVANIZED 90-DEGREE SWEEP ELBOW

90-Degree Sweep Elbow for large-radius turns.

BULLETIN: F40GF

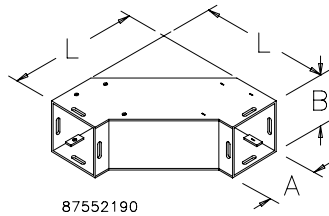

Catalog Number	AxB in./mm	L in./mm
F2290SEGV	2.50 x 2.50 64 x 64	7.91 201
F4490SEGV	4.00 x 4.00 102 x 102	9.41 239
F6690SEGV	6.00 x 6.00 152 x 152	11.34 288
F8890SEGV	8.00 x 8.00 203 x 203	13.44 341
F101090SEGV	10.00 x 10.00 254 x 254	15.62 395
F121290SEGV	12.00 x 12.00 305 x 305	17.44 443

GALVANIZED 90-DEGREE ELBOW-TEE-CROSS

Forms left or right 90-degree turns. Can be used as a tee or cross. Use with open adapter for cable entrance in top and bottom. Includes two closure plates.

BULLETIN: F40GF

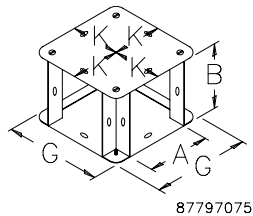

Catalog Number	AxB in./mm	G in./mm	K in./mm
F2290TXGV	2.50 x 2.50 64 x 64	4.50 114	2.25 57
F4490TXGV	4.00 x 4.00 102 x 102	6.00 152	3.00 76
F6690TXGV	6.00 x 6.00 152 x 152	8.00 203	4.00 102
F8890TXGV	8.00 x 8.00 203 x 203	10.00 254	5.00 127
F101090TXGV	10.00 x 10.00 254 x 254	12.00 305	6.00 152
F121290TXGV	12.00 x 12.00 305 x 305	14.00 356	7.00 178

GALVANIZED 90-DEGREE ELBOW

Any side can be removed, retaining lay-in feature regardless of how the elbow is oriented. Sides are held together with screws.

BULLETIN: F40GF

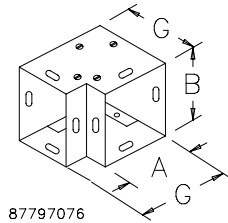

Catalog Number	AxB in./mm	G in./mm
F2290EGV	2.50 x 2.50 64 x 64	4.50 114
F4490EGV	4.00 x 4.00 102 x 102	6.00 152
F6690EGV	6.00 x 6.00 152 x 152	8.00 203
F8890EGV	8.00 x 8.00 203 x 203	10.00 254
F101090EGV	10.00 x 10.00 254 x 254	12.00 305
F121290EGV	12.00 x 12.00 305 x 305	14.00 356

GALVANIZED 90-DEGREE ELBOW—OUTSIDE OPENING

For continuous run with 90-degree turns. Top, bottom and outside covers removable.

BULLETIN: F40GF

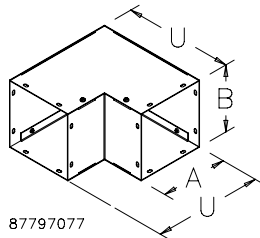

Catalog Number	AxB in./mm	U in./mm
F2290EOUTGV	2.50 x 2.50 64 x 64	6.50 165
F4490EOUTGV	4.00 x 4.00 102 x 102	8.00 203
F6690EOUTGV	6.00 x 6.00 152 x 152	10.00 254
F8890EOUTGV	8.00 x 8.00 203 x 203	12.00 305
F101090EOUTGV	10.00 x 10.00 254 x 254	14.00 356
F121290EOUTGV	12.00 x 12.00 305 x 305	16.00 406

GALVANIZED 90-DEGREE ELBOW—INSIDE OPENING

For continuous run with 90-degree turns. Top and inside covers removable.

BULLETIN: F40GF

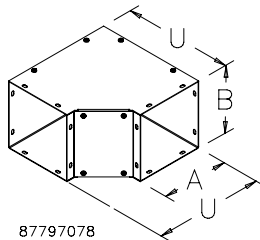

Catalog Number	AxB in./mm	U in./mm
F2290EINGV	2.50 x 2.50 64 x 64	6.50 165
F4490EINGV	4.00 x 4.00 102 x 102	8.00 203
F6690EINGV	6.00 x 6.00 152 x 152	10.00 254
F8890EINGV	8.00 x 8.00 203 x 203	12.00 305
F101090EINGV	10.00 x 10.00 254 x 254	14.00 356
F121290EINGV	12.00 x 12.00 305 x 305	16.00 406

GALVANIZED 45-DEGREE ELBOW

Any side can be removed, retaining lay-in feature regardless of how the elbow is oriented. Sides are held together with screws.

BULLETIN: F40GF

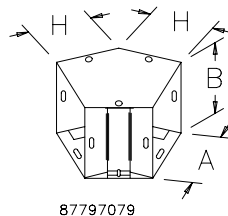

Catalog Number	AxB in./mm	H in./mm
F2245EGV	2.50 x 2.50 64 x 64	2.75 70
F4445EGV	4.00 x 4.00 102 x 102	3.38 86
F6645EGV	6.00 x 6.00 152 x 152	4.25 108
F8845EGV	8.00 x 8.00 203 x 203	5.06 129
F101045EGV	10.00 x 10.00 254 x 254	6.00 152
F121245EGV	12.00 x 12.00 305 x 305	6.75 171

GALVANIZED TELESCOPE FITTING

Length easily adjusts to approximately 12.00 in. (305 mm). No cutting or welding required.

BULLETIN: F40GF

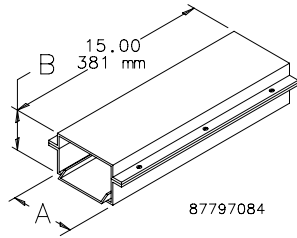

GALVANIZED PANEL ADAPTER

A flanged fitting which allows the wireway to be securely connected to an enclosure.

BULLETIN: F40GF

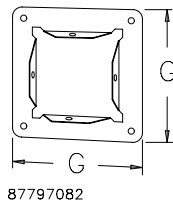

GALVANIZED CLOSURE PLATE, WITH AND WITHOUT KNOCKOUTS

Closes the end of a wireway section or run.

BULLETIN: F40GF

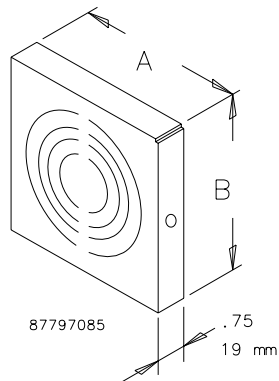

Catalog Number	AxB in./mm
F22GAGV	2.50 x 2.50 64 x 64
F44GAGV	4.00 x 4.00 102 x 102
F66GAGV	6.00 x 6.00 152 x 152
F88GAGV	8.00 x 8.00 203 x 203
F1010GAGV	10.00 x 10.00 254 x 254
F1212GAGV	12.00 x 12.00 305 x 305

Not UL/cUL listed.

Catalog Number	G (in.)	G (mm)
F22GPAGV	4.50	114
F44GPAGV	6.00	152
F66GPAGV	8.00	203
F88GPAGV	10.00	254
F1010GPAGV	12.00	305
F1212GPAGV	14.00	356

Catalog Number	AxB in./mm	Knockouts
F22GCPGV	2.00 x 2.00 64 x 64	With knockouts
F22GCPNKGV	2.00 x 2.00 64 x 64	Without knockouts
F44GCPGV	4.00 x 4.00 102 x 102	With knockouts
F44GCPNKGV	4.00 x 4.00 102 x 102	Without knockouts
F66GCPGV	6.00 x 6.00 152 x 152	With knockouts
F66GCPNKGV	6.00 x 6.00 152 x 152	Without knockouts
F88GCPGV	8.00 x 8.00 203 x 203	With knockouts
F88GCPNKGV	8.00 x 8.00 203 x 203	Without knockouts
F1010GCPNKGV	10.00 x 10.00 254 x 254	Without knockouts
F1212GCPGV	12.00 x 12.00 305 x 305	With knockouts
F1212GCPNKGV	12.00 x 12.00 305 x 305	Without knockouts

REDUCER

Reduces wireway to a smaller size.

BULLETIN: F40PF

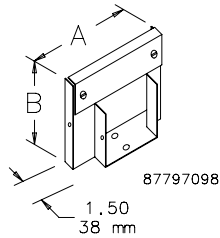

Catalog Number	AxB in./mm
F44G22R	4.00 x 4.00 102 x 102
F66G44R	6.00 x 6.00 152 x 152
F88G66R	8.00 x 8.00 203 x 203
F1010G88R	10.00 x 10.00 254 x 254
F1212G88R	12.00 x 12.00 305 x 305
F1212G1010R	12.00 x 12.00 305 x 305

GALVANIZED SUPPORT HANGER

For floor or wall installations.

BULLETIN: F40GF

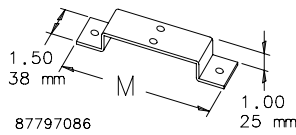

Catalog Number	M (in.)	M (mm)
F22GSHGV	4.62	117
F44GSHGV	6.12	155
F66GSHGV	8.12	206
F88GSHGV	10.12	257
F1010GSHGV	12.12	308
F1212GSHGV	14.12	359

DROP AND BRACKET HANGERS

Drop and bracket hangers support a wireway run.

BULLETIN: F40PF

Catalog Number	N max. (in.)	N max. (mm)	P (in.)	P (mm)	R (in.)	R (mm)	S (in.)	S (mm)	T (in.)	T (mm)
F22GDB	8.50	216	4.50	114	3.38	86	7.25	184	3.75	95
F44GDB	10.50	267	6.00	152	4.12	105	9.25	235	4.50	114
F66GDB	15.00	381	7.12	181	5.12	130	13.75	349	5.50	140
F88GDB	21.00	533	10.81	275	7.00	178	13.75	349	7.75	197
F1010GDB	22.00	559	13.81	335	8.38	213	13.75	349	10.25	260
F1212GDB	23.00	584	15.56	395	9.78	248	13.75	349	12.50	318

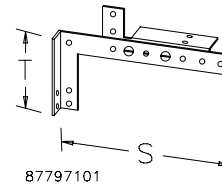
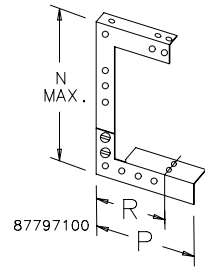

GALVANIZED UNIVERSAL U-CONNECTOR

Joins wireway sections and fittings. Top swings aside to retain the lay-in feature. One U-connector required at each wireway joint except telescope fittings, panel adapters, open adapters, closure plates or reducers.

BULLETIN: F40GF

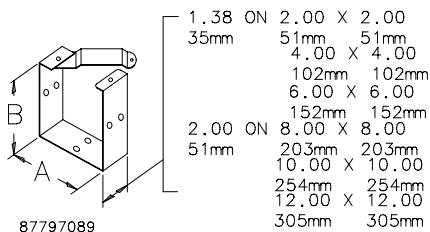

Catalog Number	AxB in./mm
F22GUCGV	2.50 x 2.50 64 x 64
F44GUCGV	4.00 x 4.00 102 x 102
F66GUCGV	6.00 x 6.00 152 x 152
F88GUCGV	8.00 x 8.00 203 x 203
F1010GUCGV	10.00 x 10.00 254 x 254
F1212GUCGV	12.00 x 12.00 305 x 305